

SERIAL No. / PRODUCT No. GUIDE

| | |
|-------------------------------|---|
| SERIAL#XXXXXXXX | Serial n°, Serijski broj, Партиден номер, Sériové číslo, Serienummer, Serie nummer, Seerianumber, Sarjanumero, Numéro de série, Sorozatszám, Serijos numeris, Sērijas numurs, Serienummer, Număr de serie, Серийный номер, Sériové číslo, Serienummer, Seri numarasi, Seriennummer, Número de serie, Numero di serie, Numer seryjny, Série n°, Serijski broj, Serijski broj, Serijska številka, Σειριακός αριθμός |
| #XXXXX ----- #PXXXXX | Product n°, Broj proizvoda, Модел, číslo produktu, Artikelnummer, Product nummer, Tootenumber, Tuotenumero, Numéro de produit, Termék száma, Gaminio numeris, Produkta numurs, Artikkelnummer, Numărul produsului, Код товара, číslo výrobku, Artikelnummer, Ürün numarası, Produktnummer, Número de producto, Codice prodotto, Numer produktu, Produto n°, Proizvod broj, Broj proizvoda, Izdelek števi |
| YYYY-MM-DD ----- DDMMYY | Production date, Datum proizvodnje, Дата на производство, Datum výroby, Produktionsdato, Productie datum, Tootmisnumber, Tuotantopäivä, Date de production, Gyártás időpontja, Pagaminimo data, Ražošanas datums, Produksjonsdato, Data fabricației, Дата производства, Dátum výroby, Produktionsdatum, Üretim tarihi, Herstellungsdatum, Fecha de fabricación, Data di produzione, Data produkcji, Data de produção, Datum proizvodnje, Datum proizvodnje, Datum proizvodnje, Ημερομηνία παραγωγής |

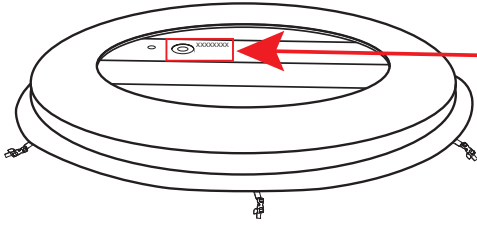

XXXXXXXXXXXXXX
 #XXXXXXX
 YYYY-MM-DD/DDMY

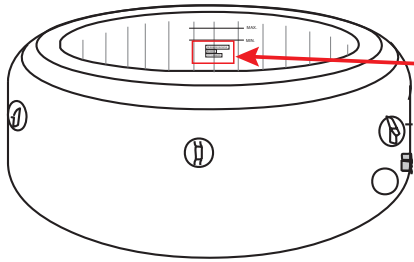

— MAX.
 — MIN.
 SERIAL#XXXXXXXXXX
 #XXXXX / #XXXXXXXXXXXXXX
 YYYY-MM-DD/DDMY

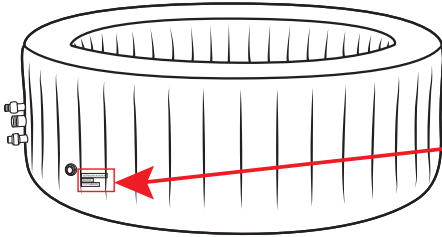

1 SERIAL#XXXXXXXXXX
 #XXXXX / #XXXXXXXXXXXXXX
 YYYY-MM-DD/DDMY

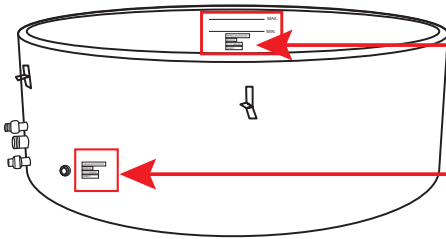

— MAX.
 — MIN.
 SERIAL#XXXXXXXXXX
 #XXXXX / #XXXXXXXXXXXXXX
 YYYY-MM-DD/DDMY

1
 SERIAL#XXXXXXX
 #XXXXX / #XXXXXXXXXXXXXX
 YYYY-MM-DD/DDMY

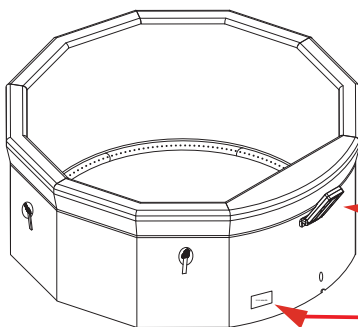

#PXXXXX

XXXXXXXXXX
 YYYY-MM-DD/DDMY

1 SERIAL#XXXXXXX
 #XXXXX / #XXXXXXXXXXXXXX
 YYYY-MM-DD/DDMY

SERIAL#XXXXXXXX
#XXXXXXXXXXXX
DDMMYY

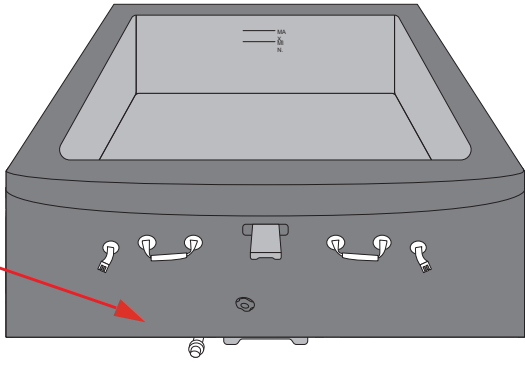

SERIAL#XXXXXXXX
#XXXXXXXXXXXX
DDMMYY

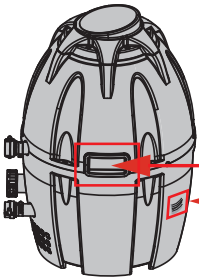
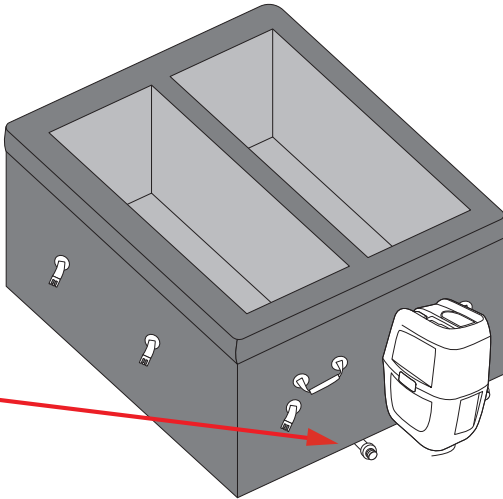

YYYY-MM-DD

#XXXXX

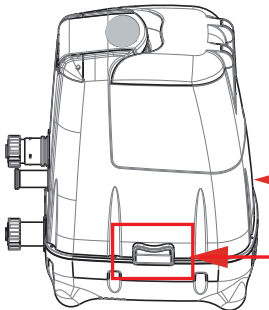

#PXXXXX

XXXXXXXXXX

YYYY-MM-DD

XXXXXXXXXX

DDMMYY

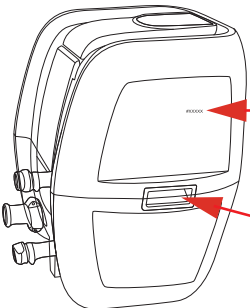

#XXXXX

YYYY-MM-DD/DDMMYY

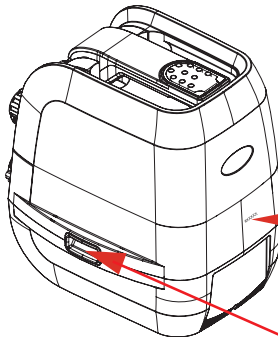

#PXXXXX

XXXXXXXXXX

YYYY-MM-DD

XXXXXXXXXX

DDMMYY



DDMMYY

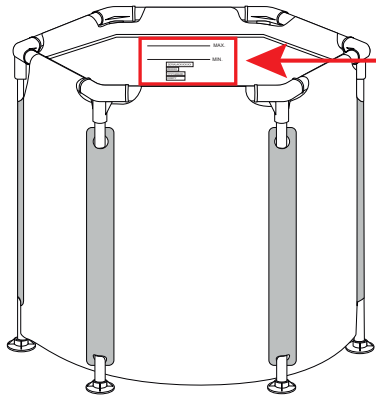

— MAX.
— MIN.
SERIAL#XXXXXXXXXX
#XXXXXXXXXXXXXX
DDMMYY

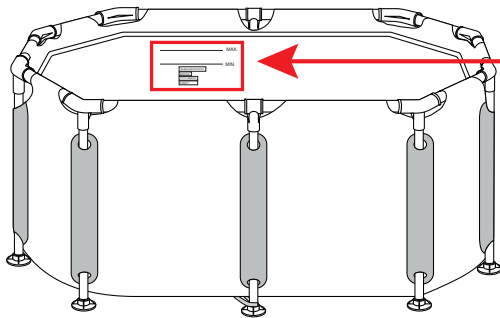

— MAX.
— MIN.
SERIAL#XXXXXXXXXX
#XXXXXXXXXXXXXX
DDMMYY

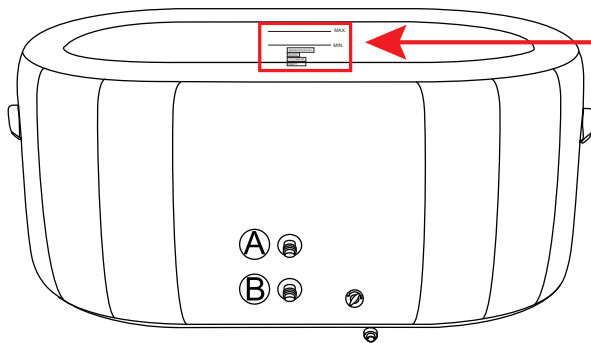

— MAX.
— MIN.
SERIAL#XXXXXXXXXX
#XXXXXXXXXXXXXX
DDMMYY

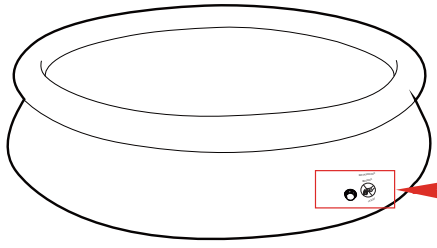
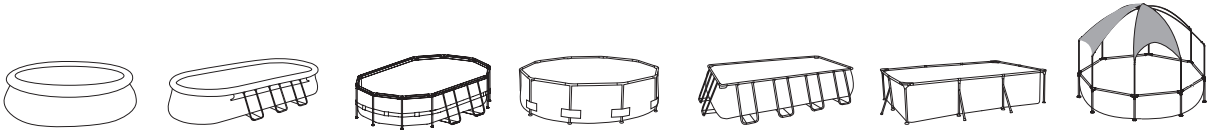

SERIAL#XXXXXXXXX
 #XXXXXXXXXXXXX
 YYYY-MM-DD/DDMY
 10'X30"

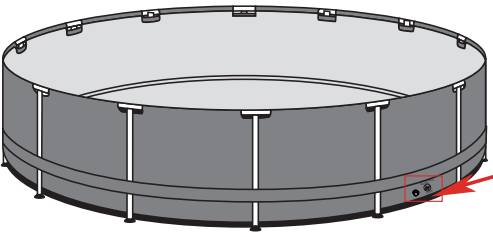

SERIAL#XXXXXXXXX
 #XXXXXXXXXXXXX
 YYYY-MM-DD/DDMY
 15'X48"

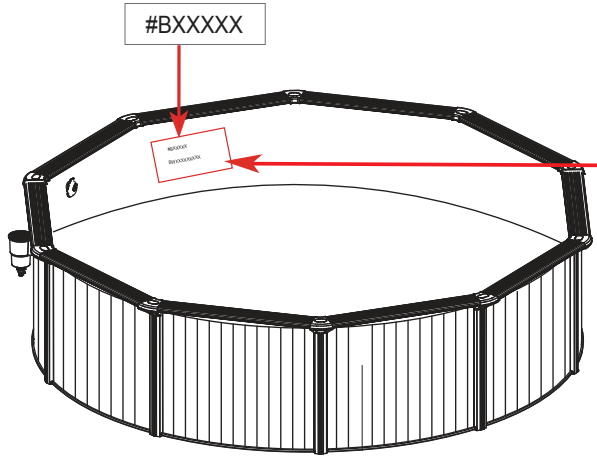

SERIAL#XXXXXXXXX
 #XXXXXXXXXXXXX
 YYYY-MM-DD/DDMY

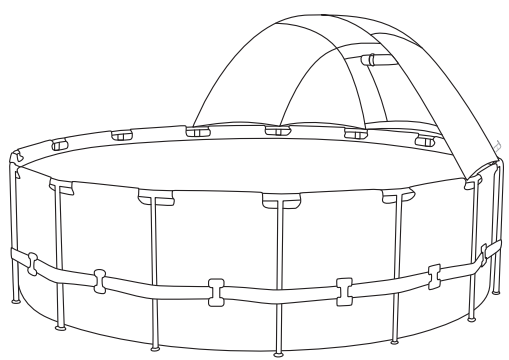

YYYY-MM-DD/DDMY

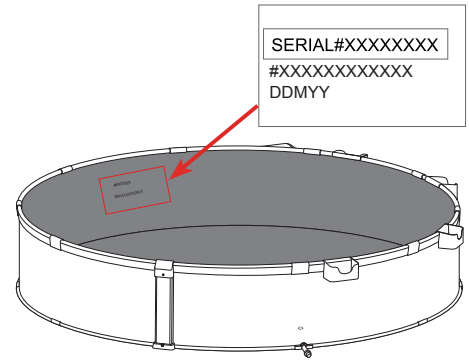

SERIAL#XXXXXXXXX
 #XXXXXXXXXXXXX
 DDMYY

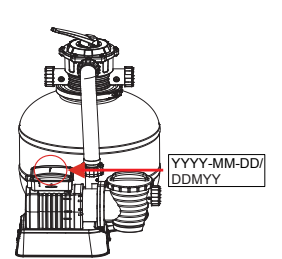
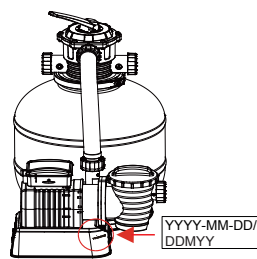
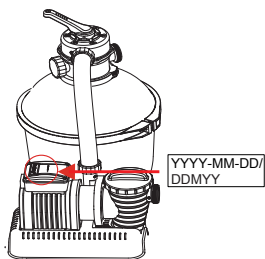
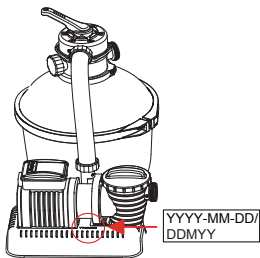
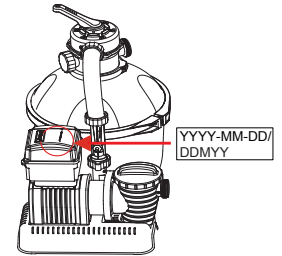
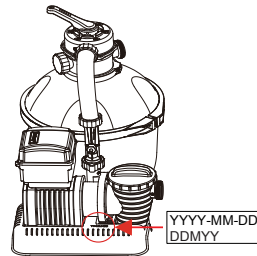
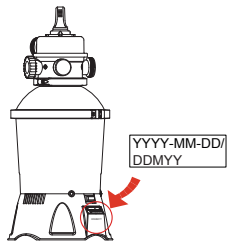
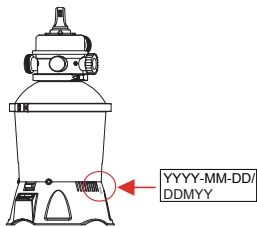
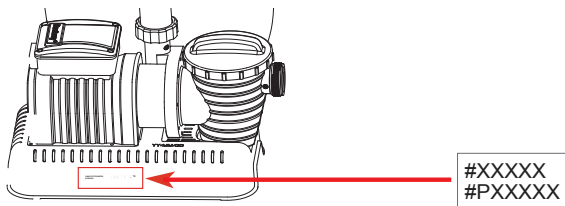
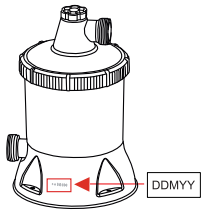
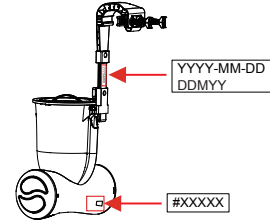
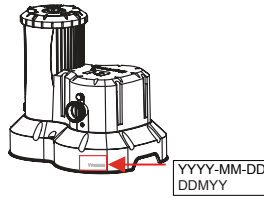
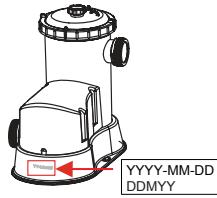
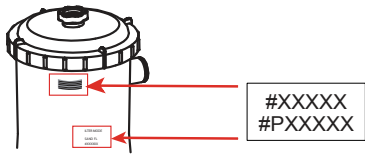

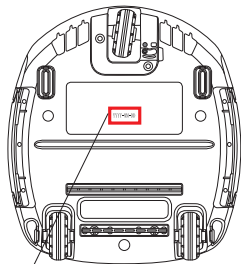
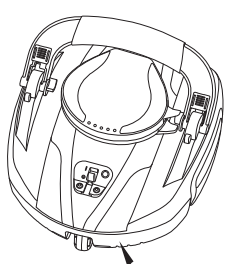

YYYY-MM-DD/
DDMY

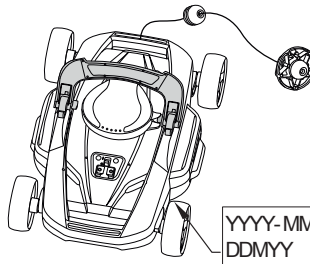

YYYY-MM-DD/
DDMY

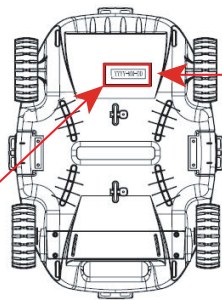
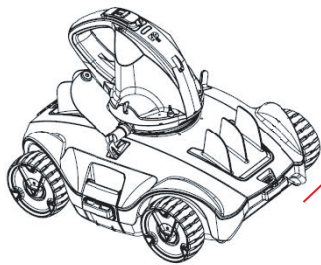
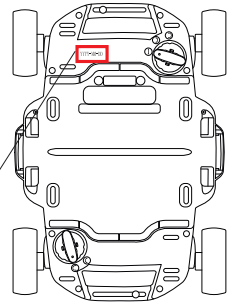

YYYY-MM-DD/DDMY

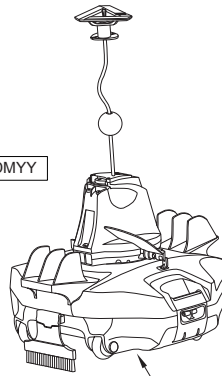

YYYY-MM-DD/
DDMY

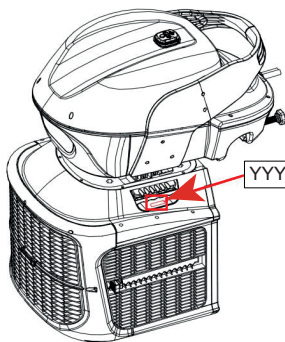
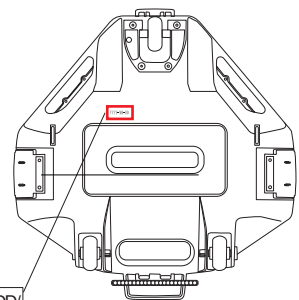

YYYY-MM-DD/DDMY

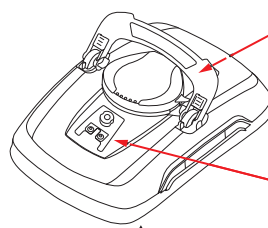

DDMY

DDMY

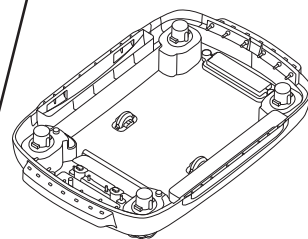
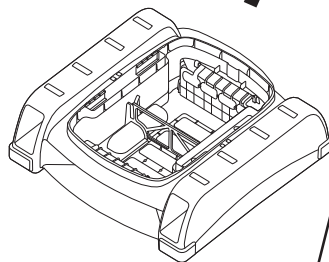
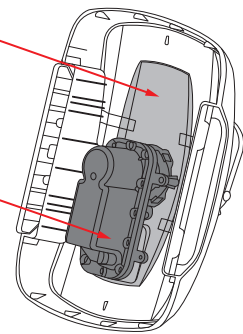

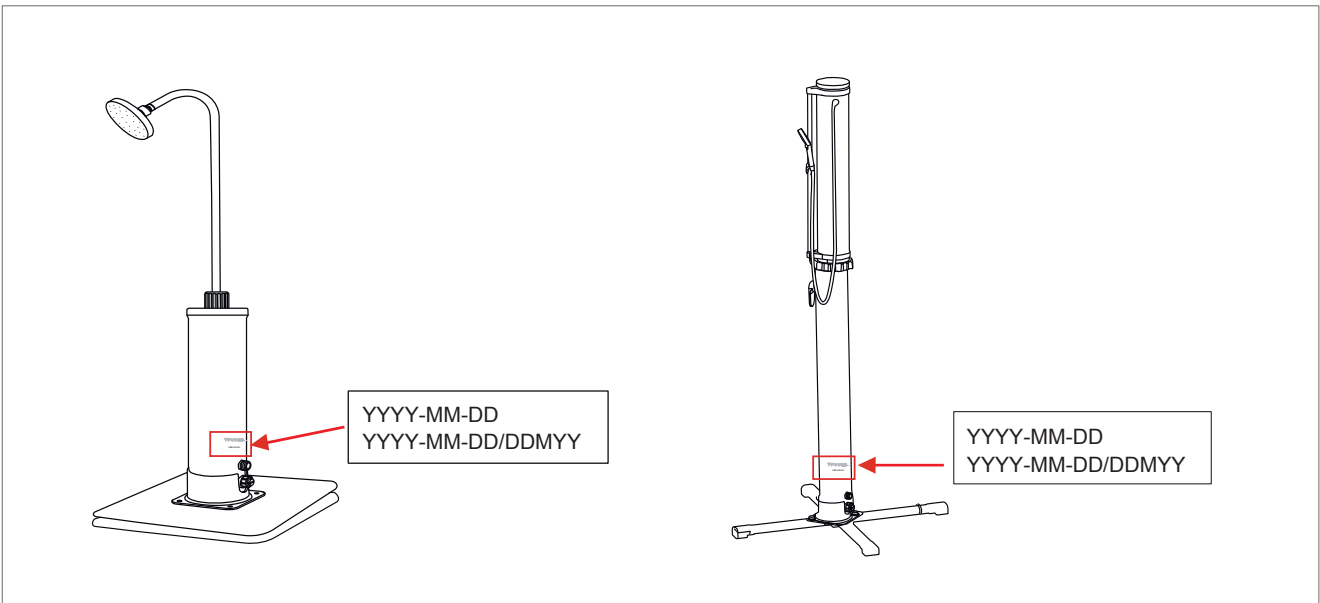
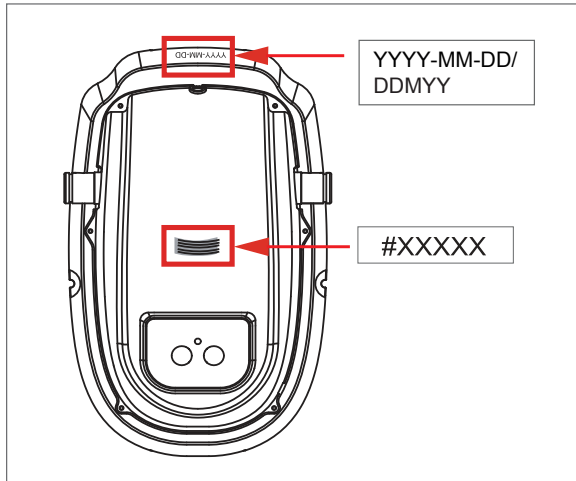
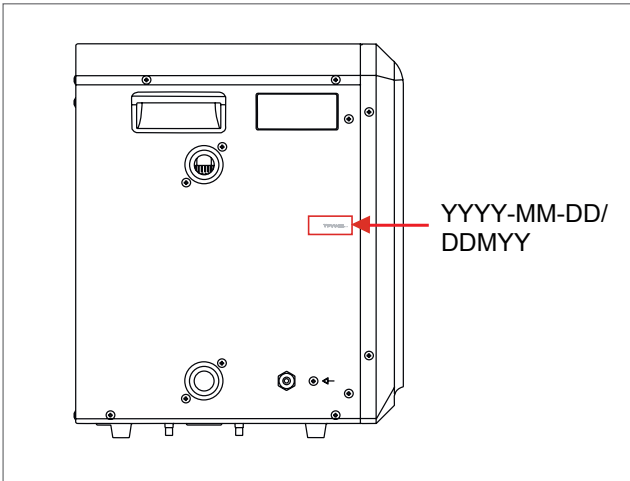
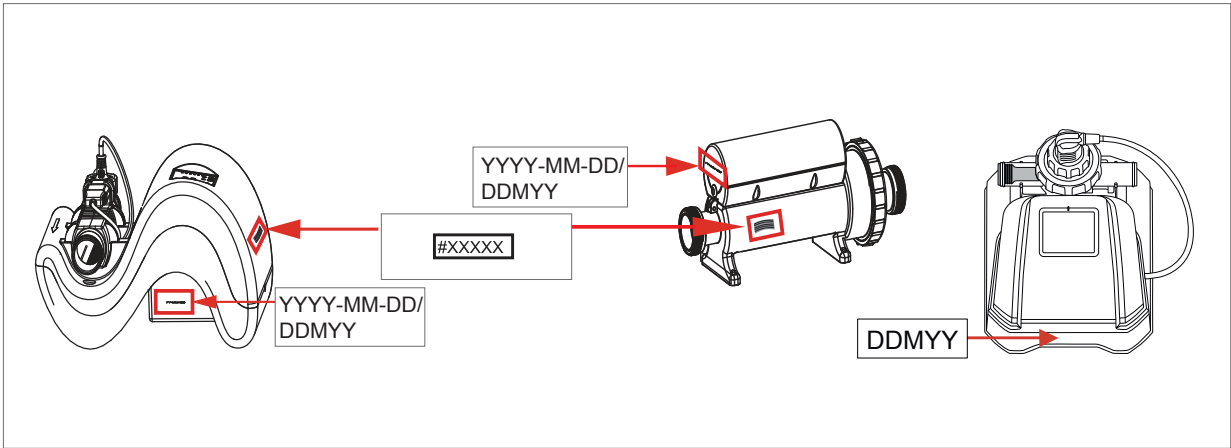

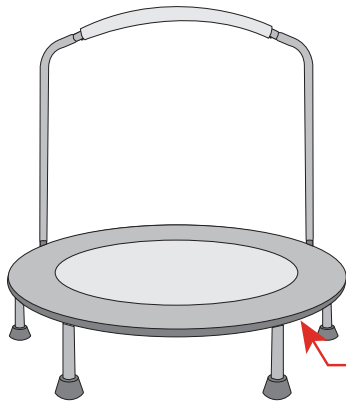

XXXXXX
DDMY

SERIAL#XXXXXXXXXXXX
DDMY

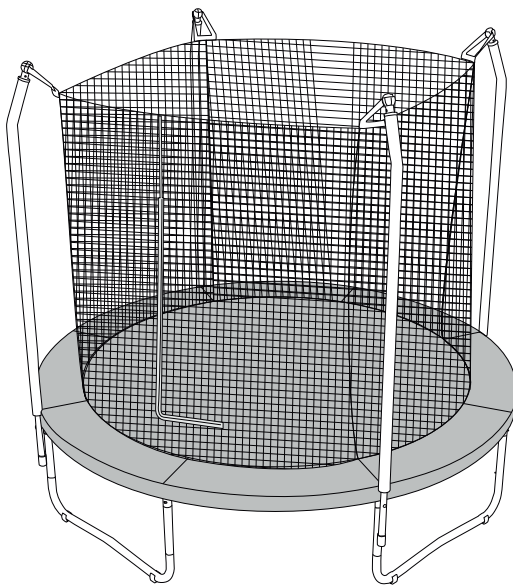

XXXXXX
DDMY

SERIAL#XXXXXXXXXXXX
DDMY

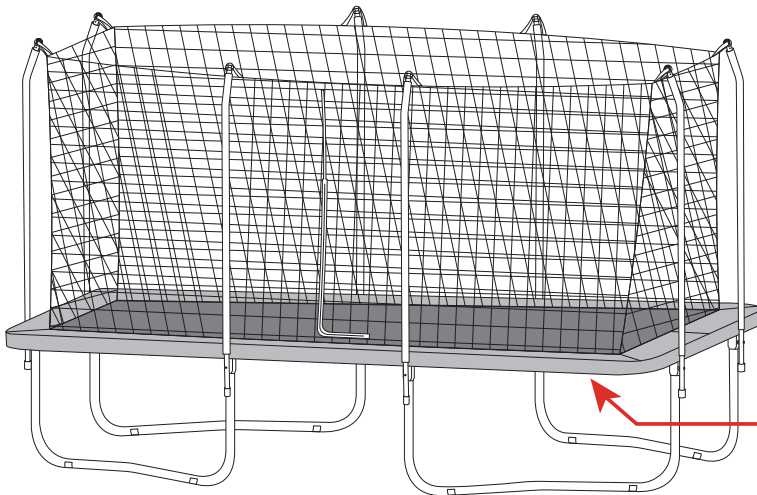

SERIAL#XXXXXXXXXXXX
DDMY



XXXXXXXX
DDMY

XXXXXXXX
YYYY-MM-DD

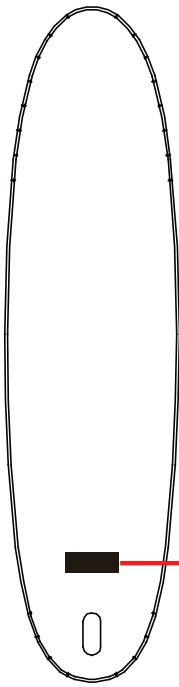

XXXXXXXX
DDMY

XXXXXXXX
YYYY-MM-DD